



HEAVY DUTY MOWER

PEO 21 #502



ASSEMBLY and OPERATING INSTRUCTIONS

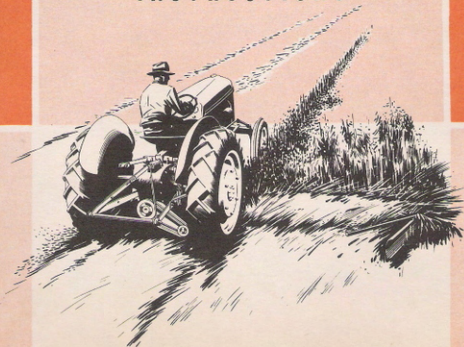

HARRY FERGUSON, INC. • DETROIT 3, MICHIGAN

FERGUSON

HEAVY DUTY MOWER

THE FERGUSON HEAVY DUTY MOWERS are designed to utilize the exclusive Ferguson System. It will successfully mow slopes from vertical to 45° below horizontal. The finger-tip control of the Ferguson System permits holding the cutter bar in any position throughout this range of movement. This effortless control from the tractor seat gives the operator instant positive control of the mower bar, and is one of the reasons for the large daily capacity of this mower, even in adverse mowing conditions. The rugged Ferguson Heavy Duty Mower gives outstanding performance in heavy industrial and highway mowing and is equally outstanding in all types of farm mowing.

This manual contains definite illustrations and information concerning the adjustment, operation, service, and maintenance of the Ferguson Heavy Duty Mower. Read this manual, study and retain it. Follow the instructions and suggestions in this manual and you will receive the satisfaction, the long life, and the performance built into this equipment. If any questions arise, contact your Ferguson dealer; he is interested in your satisfaction—carries repair parts, and has personnel who are familiar with and thoroughly understands the operation of this equipment.

Permit the installation of only *Genuine Repair Parts* purchased from your *Ferguson* dealer. These parts are manufactured with the same care and precision exercised in production of the original implement. This insures exact dimensions, uniformity, hardness, quality of material and interchangeability of parts.

NOTE: For convenience of the reader, each illustration carries the same number as the page on which it appears. Where there are two or more illustrations on each page, each carries a suffix to designate it from the other illustrations on the same page. When reference is made to illustration 18, for example, it will be found on page 18.

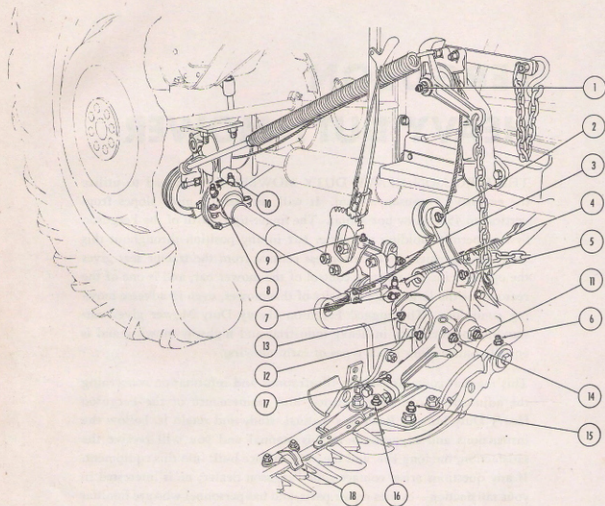

Fig. 2

Lubrication

1. Lubricate the following grease fittings using chassis lubricant.
 - a. Fittings, 1 to 10—every 10 hrs.
 - b. Fittings, 11 to 13—every 5 hrs.
 - c. Fittings, 14 to 17—four times daily.
2. Lubricate point 18 and all other knife clips with heavy oil or grease four times daily except in sandy, abrasive conditions.
3. Lubricate lifting cables at the sheaves, using graphite grease or heavy oil.
4. Keep cutter bar and knife coated with rustproof compound when mower is not in use.

Caution: Do not under any circumstances, oil or grease the four rubber bushings used in the drag bar mounting.

Caution: Do not lubricate clips when

Breaking-in Period

Your new mower should be given a reasonable amount of special attention during the first few days of operation.

Do not attempt to make an adjustment without first disengaging power take-off and shutting off tractor engine.

1. Check and tighten all nuts and bolts before starting and occasionally thereafter.
2. Lubricate, following procedure outlined on Page 2.
3. Check the cutter bar guards for correct registering of the sickle sections (See Page 14).
4. Check the belts for tension (See Page 14).
5. Operate the tractor engine idle with power take-off engaged, being sure that all parts are working freely.
6. Inspect bearings and knife guides for over-heating several times during the first few hours.

7. Check the levers and the controls for proper operations. See Page 26 for proper cable tension.

Safety Release

When an obstruction is struck by the cutter bar, injury to mower or tractor is prevented by the automatic safety device, Fig. 3, which disengages tractor clutch, thus stopping forward motion of the tractor and the cutting motion of the sickle.

To resume mowing, the operator merely has to relieve pressure of the obstacle on the cutter bar by backing the tractor. It may be necessary to pull the Power Take-Off lever to the "off" position in order that the gear shift lever can be moved to reverse. The clutch is re-engaged by raising the pedal with the toe.

The pull spring, H, Fig. 6, hooked to the front axle regulates the force needed in engaging the safety release. To prevent the mower bar from losing its lead in exceptionally heavy cutting, it may be necessary to hook the spring in the second chain link.

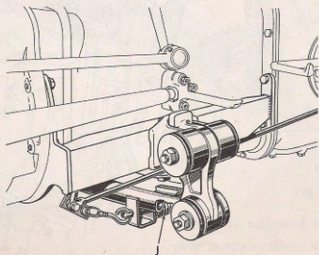

Fig. 3

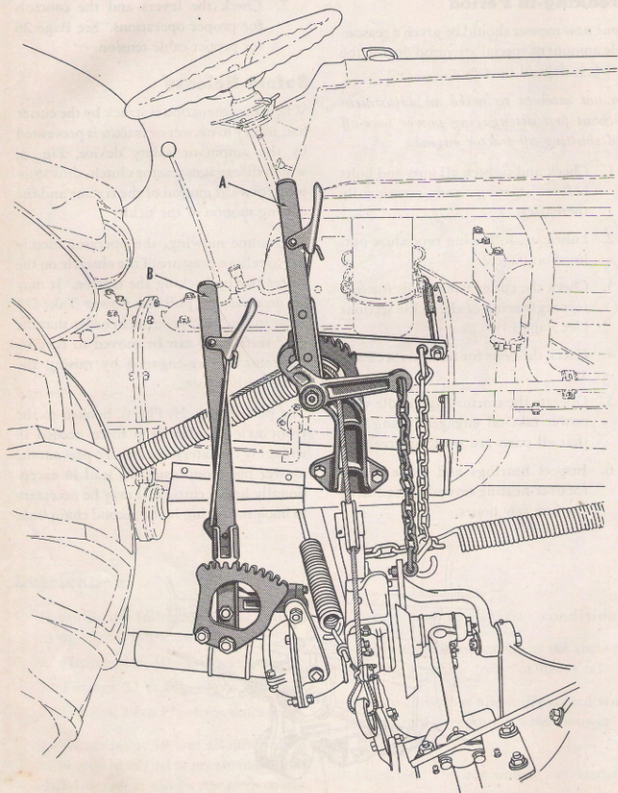

Fig. 4

Tilt Lever

The tilt lever, B, Fig. 4, adjusts the cutting angle of the bar. Under most conditions the guards should run level with the ground, but when cutting hay that is lodged it may be advisable to tilt the bar forward.

Curb Lift

The curb lift (extra equipment) A, Fig. 3, consists of a lever and a ratchet. This comes

assembled on the mower when ordered with the mower. On mowers not fitted with curb lift, a spacer is used on the pedestal pin in place of the lever, thus the curb lift can be easily installed at any future time.

The curb lift lever establishes the lowest position that the inner shoe may ride, and may be adjusted so the shoe rides a maximum of 12" above the ground.

Shoe Adjustment

The shoes can be adjusted to permit the bar (1) to ride close to the ground for close clipping; (2) raised to allow several inches of stubble. Adjust inner shoe at C, Fig. 5a, and outer shoe at point D, Fig. 5b. These adjustments control stubble height and should be adjusted so that both ends of the cutter bar are the same distance from the ground. To protect the cutter bar when mowing on rough or stony fields, the shoes

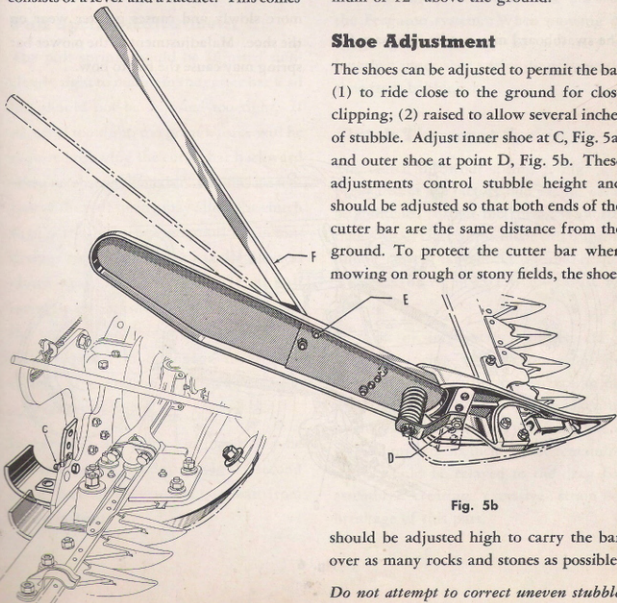

Fig. 5a

Fig. 5b

should be adjusted high to carry the bar over as many rocks and stones as possible.

Do not attempt to correct uneven stubble height by lift spring adjustments.

Swathboard and Stick

The swathboard E, Fig. 5b, and stick F, should be adjusted, so the cut grass will lie well to the left of the swath to allow a path for the inner shoe the next time around. The end of the stick should be raised for cutting tall grass and lowered for cutting short grass.

The swathboard may not be necessary for highway work.

Mower Bar Spring

The mower bar spring G, Fig. 6, relieves the weight on the outer shoe and should be adjusted so that the shoe follows the contour of the ground. In heavy cutting it may be necessary to loosen the mower bar spring to permit the bar to stay down under the hay and to prevent outer shoe bobbing. Loosening of this spring makes the bar lift more slowly and causes greater wear on the shoe. Maladjustment of the mower bar spring may cause the bar to bow.

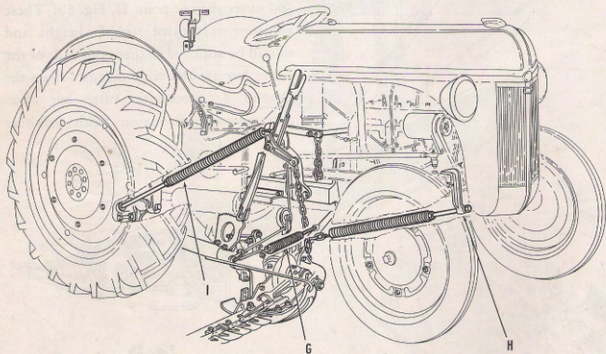

Fig. 6

Pull Spring

The pull spring H, Fig. 6, holds the cutter bar in the correct cutting position, maintaining mower bar lead, but allowing the cutter bar to swing backward when an obstruction is hit, thus disengaging the tractor clutch and stopping the forward motion of the tractor and the cutting motion of the sickle.

Pull Spring Adjustment

The pull spring should be adjusted sufficiently tight to maintain the cutter bar lead but should not be adjusted too tight. If adjusted too tight, too great a force will be required to swing the cutter bar backward when an obstruction is hit. Insufficient tension of the pull spring may allow the clutch to be partially disengaged, resulting in continuous tractor clutch slippage and excess clutch wear. To check tension of the pull spring, pull backward on the outer end of the cutter bar. This pull represents the force required to disengage the tractor clutch. It should be adjusted to suit the operating conditions.

In exceptionally heavy cutting it may be necessary to hook the spring in the second chain link to prevent mower bar from losing its lead.

Inner Shoe Spring

The inner shoe spring, I, Fig. 6, takes part of the inner cutter bar weight off the ground, thereby reducing weight on the inner shoe sole. This spring should be adjusted so the inner shoe will follow the contour of the ground and can be easily lifted with the hand. If adjusted too tight, the inner shoe will raise first, thus making bar raise slowly, when raising the bar with the Ferguson system. When mowing on rough ground it may be necessary to lengthen inner shoe spring to prevent the shoe from bobbing.

Clutch Throwout Spring

The clutch throwout spring J, Fig. 3, is preloaded at the factory and should *never* be tightened so that the spring is shorter than 3½". Tight adjustment will transmit minor cutter bar shocks to the tractor clutch, resulting in excessive wear on the clutch.

A weak or improperly adjusted clutch throwout spring will not disengage the clutch when the cutter bar strikes an object. This shock would then be taken up by the ball and seat tube, which has a telescopic motion of six inches. The remaining shock would be relayed to the drag bar assembly, creating excessive strain or breakage of this part.

Transporting

When transporting the mower, the cutter bar should be raised to its highest position with the finger-tip control. The power take-off should be disengaged and the safety

chain, Fig. 8, hooked in the hole near the outer end of the inner shoe.

Safety chain must be used if mower is expected to remain in raised position.

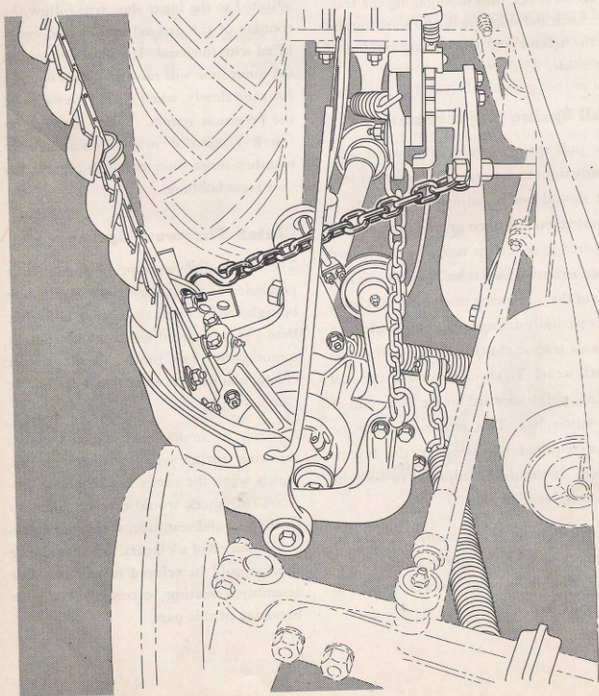

Fig. 8

Mowing Speed

The heavy duty mower's design allows correct register of knife sections with the guards through all operating angles of the cutter bar. Extra large guide surfaces are provided for the knife. The knife has a 3" stroke and the guards are spaced 3" apart.

The 8-1/2" drive pulley is standard equipment on the heavy duty mower. A 9-3/4" pulley is optional. Mowing speeds and the

proper gear ratio are determined by size of pulley used and type of grass being mowed. The following chart should be used as a guide. *Never exceed indicated top speeds shown on the chart. High speeds will cause excessive strain and wear on the mower and may result in serious damage.*

In extremely heavy cutting shift to lower gear. *Do not increase the speed of the tractor engine.*

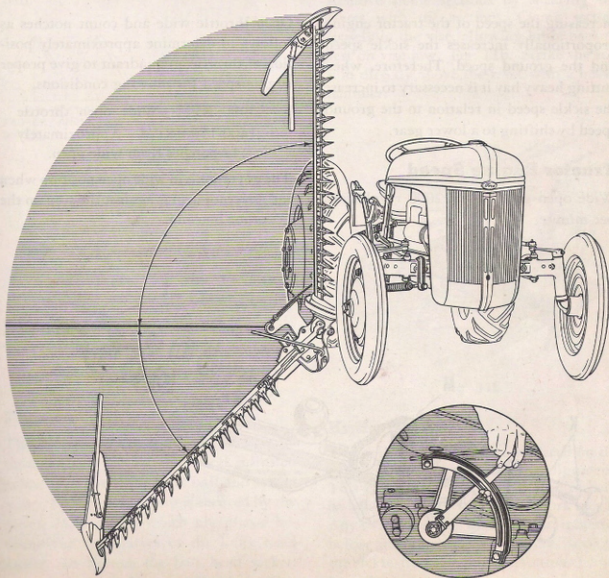

Fig. 9

MOWING SPEEDS

Pulley Diameter	Tractor Speed—Engine			Mowing Conditions	Capacity—Acres per 10-hr. day	
	Gear	RPM	MPH		5' Bar	6' Bar
8½"	2nd	1400	3.23	Average	16 to 23	19 to 27
		2000	4.62			
9¾"	2nd	1400	3.23	Heavy	16 to 19	19 to 23
		1700 ^o	3.90			
9¾"	3rd	1200 ^o	6.41	Light	20 to 30	25 to 35

^oTop speed at which tractor may be operated without excess strain and wear on mower under these mowing conditions.

NOTE: 8½ diameter pulley requires belt with 54" outside circumference (PEO-1531)

9¾ diameter pulley requires belt with 56" outside circumference (PEO-1530)

Increasing the speed of the tractor engine proportionally increases the sickle speed and the ground speed. Therefore, when cutting heavy hay it is necessary to increase the sickle speed in relation to the ground speed by shifting to a lower gear.

Tractor Engine Speed

Wide open governor is 2000 revolutions per minute.

Open throttle wide and count notches as follows to determine approximately position of throttle on quadrant to give proper engine speed for mowing conditions.

2000 RPM—Wide open throttle

1400-1500 RPM—Approximately 12 notches from wide open.

The governor is in wide open position when the governor arm is against the stop on the governor housing.

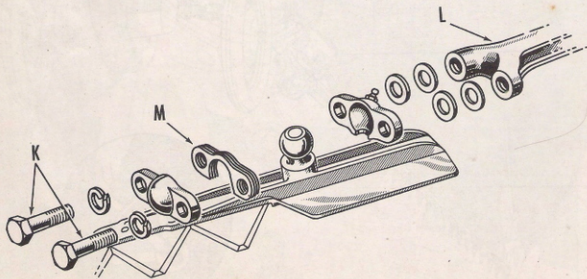

Fig. 10

Replacing Sickle

To replace a dull sickle the long cap screws on the pitman head, K, Fig. 10, should only be loosened sufficiently to let the ball sockets separate about 1". This allows the pitman to be lifted off the knife head, without any of the parts coming out of place. The knife then can be pulled out under the tractor and replaced. After replacing knife turn flywheel by hand to check knife and bar for alignment and clearance, check capscrews for tightness and grease pitman ball.

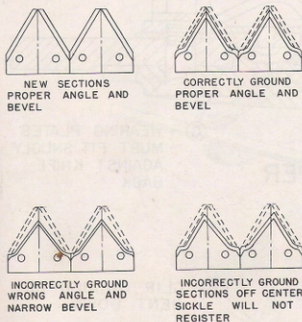

Fig. 11a

socket should be tightened sufficiently to eliminate looseness and backlash.

Sharpening Sickle

The sickle should be straight and sharp, with the sections firmly riveted. Care should be taken in sharpening the sections to preserve the original shape and bevel. Replace all worn and broken sections. Fig. 11a shows sections properly and improperly sharpened.

Removal of Sickle Sections

Remove sickle sections by shearing the rivets with the sections. Clamp section loosely in the vise, allowing knife back to rest on vise jaw. Fig. 11b. Strike the section directly above the rivet with a heavy hammer.

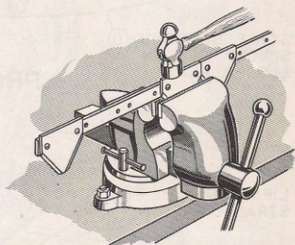

Fig. 11b

Pitman

The Pitman, L, Fig. 10, must be securely tightened at the flywheel and adjusted properly at the sickle head ball and socket joint. Proper adjustment is secured by the shims, M, Fig. 10, which are placed between the two halves of the knife head socket. To tighten the ball head socket, remove shims; to loosen, add shims. This

Knife Back

Whenever the sections are replaced on the sickle check the knife back for alignment. This is checked by laying the knife back on a flat surface such as a good work bench. Any twists or bends should be straightened before attaching the new sections. Recheck the sickle after riveting the sections on the knife back.

Guards

In order to obtain a shear cut the point of the sections must be set on the guard ledger plates, D, Fig. 12. This means that the knife and the guard ledger plates must be in alignment. The alignment of the guards may be inspected by sighting down the ledger plates or by using a taunt string. The guard should be bent up or down as

needed, with a hammer, bending the high guards down first and then bringing up the low ones. The surface of the ledger plates should align regardless of the position of the points of the guard. Strike the guard on the thick portion just ahead of the ledger plates. Be careful not to bend the lips down. See A, Fig. 12. Bent lips will cause binding and choking.

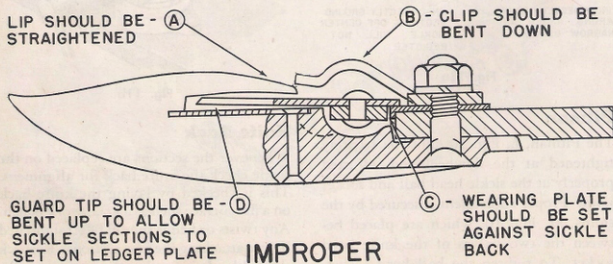
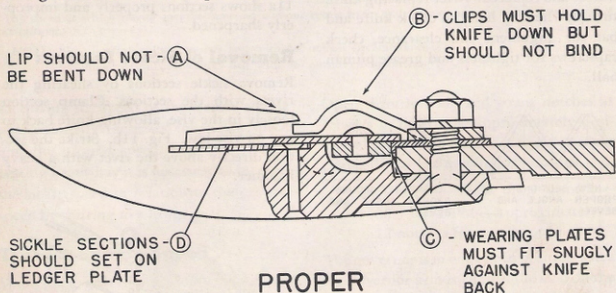

Fig. 12

The guard bolts should be tightened before and again after checking and aligning the guards.

All worn ledger plates as well as badly bent or broken guards should be replaced. Blunt guards should be repointed.

Clips

Clips, B, Fig. 12, should not be set until after the guards are aligned. Knife clips hold the sickle or knife sections to the ledger plates, but must permit sickle to

operate without binding. Adjust the clips to allow .010 clearance between the knife section and the clips. Care must be taken when this adjustment is made to be sure that the entire flat part of the clip holds the section down. The section should not be under the clips when making adjustments. These can be tapped down with a hammer. If binding occurs strike clip between the bolts while knife is under holder or bend the clip up in a vise. After setting the clips move the sickle in the bar by hand; the entire stroke should be free.

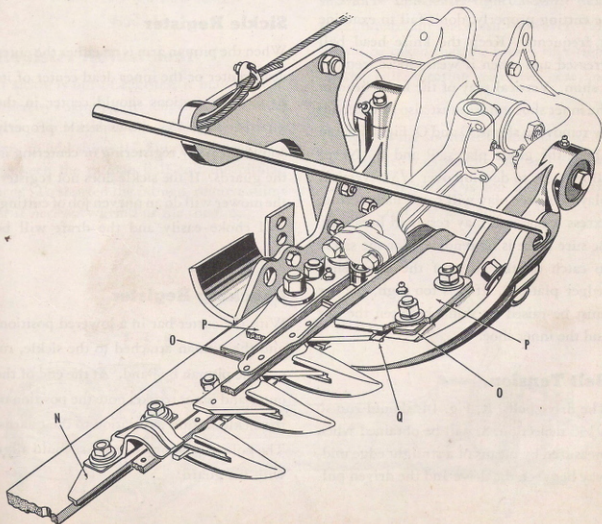

Fig. 13

Wearing Plates

The wearing plates, C, Fig. 12, should be adjusted to prevent play of the knife back in the necks of the guards. If the wearing plates are set ahead the clearance between the tips of the sections and the guards should be checked so that the sections do not strike the guards. It is essential that the wearing plates are in alignment to give the knife back a straight bearing along its entire length.

Even though your mower may appear to be cutting properly, don't fail to examine it frequently. Keep the knife head greased and when it wears loose, remove a shim. Vertical play of the knife head in the inner shoe guides must also be taken up by removing shims, O and O, Fig. 13, from under the guide plates, P and P. Never allow wear to develop over 1/32" vertical play. Greater play will cause hammering, excess wear, and may result in breakage. Be sure there is no tendency for the sickle to catch on the edge of the inner shoe ledger plate, Q. If it is too high, the bar must be raised by shims between the bar and the inner shoe.

Belt Tension

The drive belts, R, Fig. 14, should run so a 1/2" deflection, S, will be obtained when measured by means of a straight edge midway between the drive and the driven pul-

leys. This adjustment is made by a set screw T, on the pulley housing.

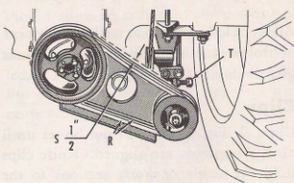

Fig. 14

Sickle Register

When the pitman arm is on either the outer dead center or the inner dead center of its stroke, the sections should center in the guards. Fig. 15a shows sickle properly and improperly registering or centering in the guards. If the sickle does not register, the mower will do an uneven job of cutting, will choke easily and the draft will be heavy.

Checking Register

With the cutter bar in a lowered position, and the pitman attached to the sickle, rotate the pitman by hand. At the end of the outer and inner stroke, note the position of the sickle section in relation to the guards. The point of the sickle section should align with the guard.

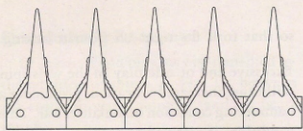

CORRECTLY CENTERED SICKLE

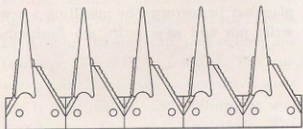

IMPROPERLY CENTERED SICKLE

Fig. 15a

Register Adjustment

If sickle is out of register, it may be remedied by changing the length of the pitman arm. To lengthen the pitman it is necessary to add shims, U, Fig. 15b, or washers between the pitman ball and the pitman arm. To shorten the pitman, remove shims or if necessary grind or file the face.

The register should always be checked after replacing pitman or knife.

Bar Alignment

The pull spring, H, Fig. 6, maintains the proper lead in the cutter bar and should be adjusted tight enough to prevent the bar from losing its lead during operation.

Pitman Ball

The pitman ball sockets, W, Fig. 15b, should be sufficiently tight on knife head to eliminate any backlash; however, care should be taken that the socket isn't tight on the ball, creating excessive heat and wear.

To tighten the socket it is necessary to remove the two capscrews, X, and remove shims, Y. If socket is too tight on ball, remove capscrew and add shims.

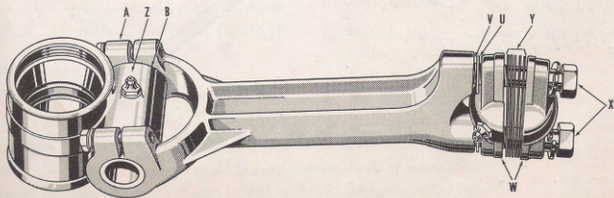

Fig. 15b

Wrist Pins

Wear allowing motion or play between the pitman boxing, Z, Fig. 15b, and the fork or yoke, A, of the pitman can be corrected by inserting shims (PEO-5507) between the boxing and the fork B. This play also may be corrected by striking the malleable fork with a hammer, closing the fork slightly

so that fork fits tight on pitman boxing.

Excessive end or side play in the wrist pin will cause increased vibration, producing a hammering condition in the cutter bar. This condition, if allowed to continue, will result in worn or broken knife head. Side play may be corrected by installing a new wrist pin and new wrist pin bushings.

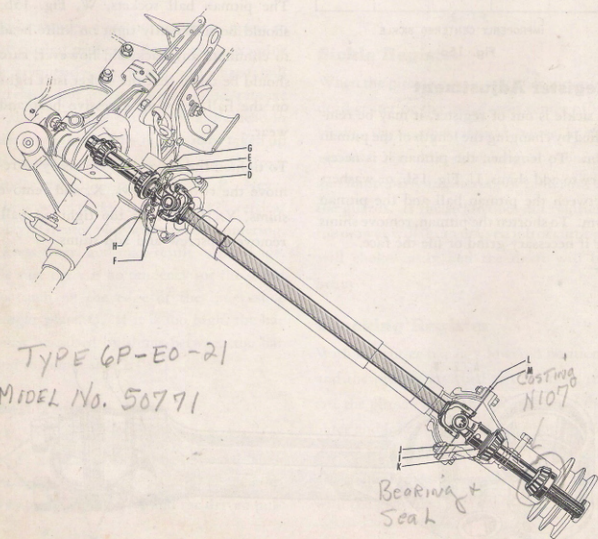

Fig. 16

Crankshaft Bearings

Crankshaft end play may be remedied by the addition of shims, C, Fig. 16, between the front universal joint, D, and the bearing, E.

In order to accomplish this shimming, it is necessary to remove the four bolts, F, from the U-joint housing cap, and remove the two pipe plugs, G, in housing. The universal joint is removed by first driving out the U-joint pin, H, and pulling the universal joint from the crankshaft. The shims* are placed on the shaft between the universal joint and the bearing.

*Driveshaft and bearing adjustment shims.

PEO 9682	.010
PEO 9683	.024
PEO 9684	.030
PEO 9685	.036

Pulley Housing Bearings

Pulley shaft end play is removed by the addition of shims, I, Fig. 16, between the rear universal joint, J, and the bearing, K.

The procedure of shimming is the same as for the crankshaft.

Be sure to reassemble driveshaft with universal joint forks in plane. See Figure 18.

Universal Ball Caps

Excessive end play may be removed from the ball caps by removing gaskets between the housing caps, L, Fig. 16.

If the shoulders on the drive shaft and universal assembly hit the ball seat it will be necessary to add shims or gaskets between outer housing caps and the housing, M.

Pitman Box Bearing

The pitman box, N, Fig. 17, has two tapered roller bearings. End play in the pitman box can be removed by tightening the castellated nut, O, right on the pitman pin and back off one castellation. The cotter pin should always lock this nut in position.

End play in the pitman box will create play in the pitman, thereby producing hammering and vibration in the cutter bar operation.

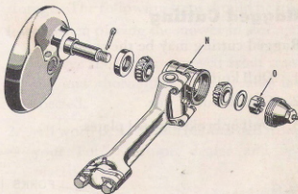

Fig. 17

Excessive Side-Draft

Side draft is an indication of non-alignment and wear. To find the source of trouble check as follows:

1. Dull knife or improperly sharpened knife.
2. Knife not in register.
3. Worn knife clips and wear plates.
4. Bent guards.
5. Maladjustment of knife guides.
6. Lack of lubrication.
7. Lagging cutter bar.
8. Bent knife back.
9. Dull ledger plates.

Knife Breaks

Knife breaks result from loose or worn cutting parts. The following should be checked.

1. Worn knife clips.
2. Worn guides.
3. Guards out of line.
4. Loose sections.
5. Worn knife head.
6. Loose or tight pitman ball connection.
7. Misalignment of cutter bar.

Ragged Cutting

Ragged cutting may be the result of:

1. Dull knife.
2. Guards out of line.
3. Dull or broken guard plates.

4. Knife not registering.
5. Loose sections.
6. Uneven adjustment of shoes.

Excessive Vibration

If mower vibrates excessively check the following:

1. Worn pitman boxing, pitman yoke and pitman pin.
2. End play in crankshaft.
3. End play in pulley shaft.
4. Excessive vertical play in knife head.
5. Driveshaft assembled with universal joints not in plane. Figure 18 shows proper and improper assembly.
6. Drag bar frozen in hinge casting or tight adjustment of drag bar to left angle member.

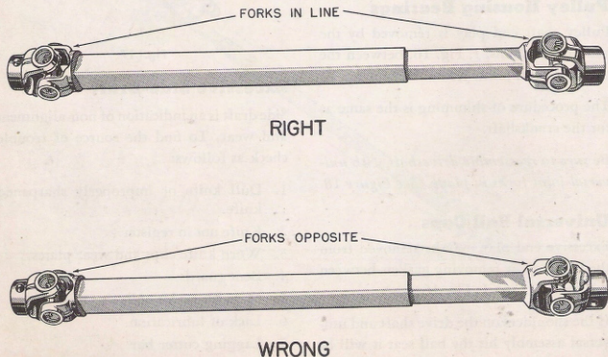

Fig. 18

Removing the Mower

1. Place tractor in a position, resting the bar on the ground.
2. Loosen belt tightener adjusting screw and remove bolts.
3. Remove belt pulley by removing two capscrews on pulley hub and loosening the third capscrew, P, Fig. 19. Insert the two capscrews, Q, into the tapped holes in the hub; tightening those two screws will pull the pulley.

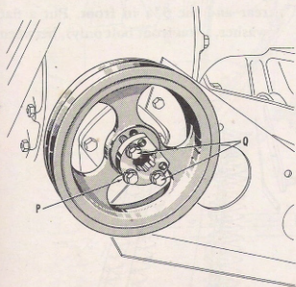

Fig. 19

4. Remove belt guard.
5. Remove capscrew, I, Fig. 26a, and sheave on curb lift pedestal. Remove cable and replace sheave and capscrew.

6. Remove drag bar bolt, 2, Fig. 24, on left angle frame.
7. Remove bolts 3, Fig. 23b, on axle bracket and slide hinge casting towards the center of the tractor and off the plate (G) Fig. 25.
8. Remove springs.
9. Back tractor away from mower.

Winter Care

The life of the mower is dependent upon the operator's care both in operation and storage. The following steps should be followed when placing the mower in storage:

1. Mower should be removed from tractor and thoroughly cleaned and inspected.
2. All worn parts should be obtained from your Ford-Ferguson dealer and replaced.
3. Remove sickle, cover with rust preventive compound and store in a safe place to protect it from damage, and to avoid possible injury to persons and animals.
4. The vee-belts should be removed and stored in a dry place.
5. The cutter bar and the shoes should be covered with rust preventive.
6. Store the mower in a dry place.

ASSEMBLY INSTRUCTIONS

1. Check Fig. 20 against standard pieces supplied with mower.
2. Tractor tread should be set for 52" rear and 48" front.
3. Remove both leveling rods, A and A, Fig. 21.
Remove power take-off cap B and lower link chains C.
4. Install stay assemblies D, Fig. 21.
5. Belt guard 1 and pulley 2, Fig. 23a. Install Pulley E and belt guard F as shown in Fig. 22. The power take-off shaft should be oiled to prevent rusting.
6. Pulley housing bracket 3, Fig. 23a. Remove right-hand fender bolts. Place plate G, Fig. 23b, under the axle housing and fasten with longer bolts supplied. Use the seven inch bolt in the rear and the 5¾ in front. Put a flat washer, I (on front bolt only), between

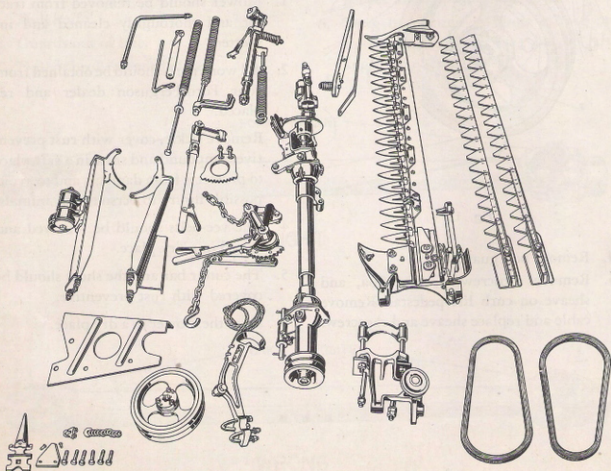

Fig. 20

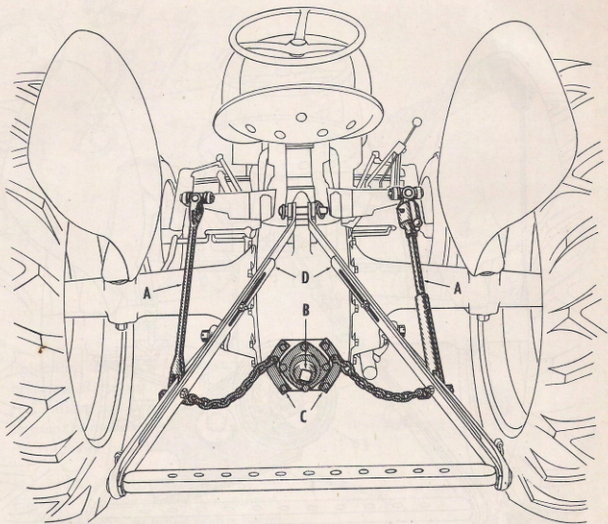

Fig. 21

the axle housing and the plate.

This corrects for the axle housing not being flat on the bottom and should bring the small belt pulley in proper alignment after the pull spring is mounted at the front axle.

7. Draw bar brace 4, Fig. 22. Attach draw-bar brace J as shown in Fig. 23a.
8. Elevating arm 5, Fig. 22. Attach elevating arm as shown in Fig. 23c.
9. Left angle member 8, Fig. 23d. Remove the three capscrews K, Fig. 24, and the two bolts L. Remove clevis pin M. Install left angle frame attaching the front and with the long capscrews provided. Install rear bolts, using

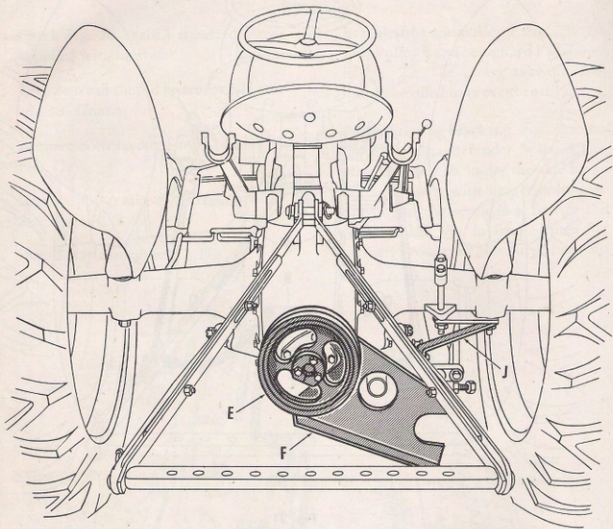

Fig. 22

washer spacers between rear end of frame and the housing to allow for variation of tractor housing length. Use as required.

10. Right angle member 9, Fig. 23d. Remove the three capscrews N, Fig. 29 and the two bolts O. *Remove flange bolts from one side of the tractor only to prevent tractor from sagging.*

Remove exhaust tube shield P. Install right angle member as following instructions outlined in Step. No. 9.

11. Brace rod 10 and brace rod bracket and curb lift 7, Fig. 23d. Attach brace rod bracket Q, Fig. 26a, if curb lift is included the ratchet will take the place of the spacer, otherwise furnished. Use lockwashers on the above bolts. Before

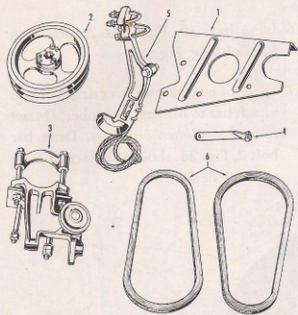

Fig. 23a

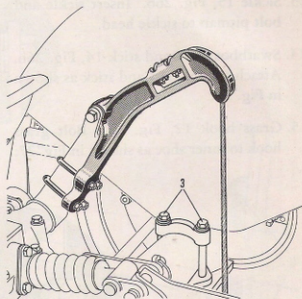

Fig. 23c

tightening the bracket in place, insert brace rod R, through hole in the outer end and start nut. Tighten bracket, then tighten the nuts on left side, the nuts on the right side and the lock nut.

12. Mower bar 11, Fig. 26b and hinge 22, Fig. 26d. Connect mower bar points A and A, Fig. 26b, to hinge points B and B, Fig. 26d. The bar should swing freely on the hinge bearing.

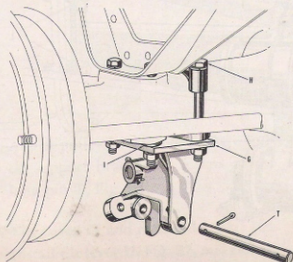

Fig. 23b

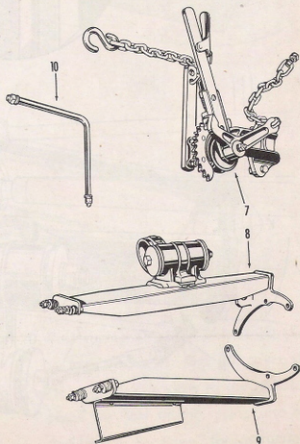

Fig. 23d

13. Sickle 15, Fig. 26b. Insert sickle and bolt pitman to sickle head.
14. Swathboard 13 and stick 14, Fig. 26b. Attach swathboard and stick as shown in Fig. 26c.
15. Grass hook 12, Fig. 26b. Bolt grass hook to inner shoe as shown in Fig. 27.
16. Drag bar, 20, Fig. 26b. Attach drag bar to hinge, Fig. 26d.
17. Drive or back tractor over drag bar and attach bar to lift angle member. *Do not lubricate rubber bushings.* Drag bar bolt 2, Fig. 24, should be slack enough to allow flexibility.

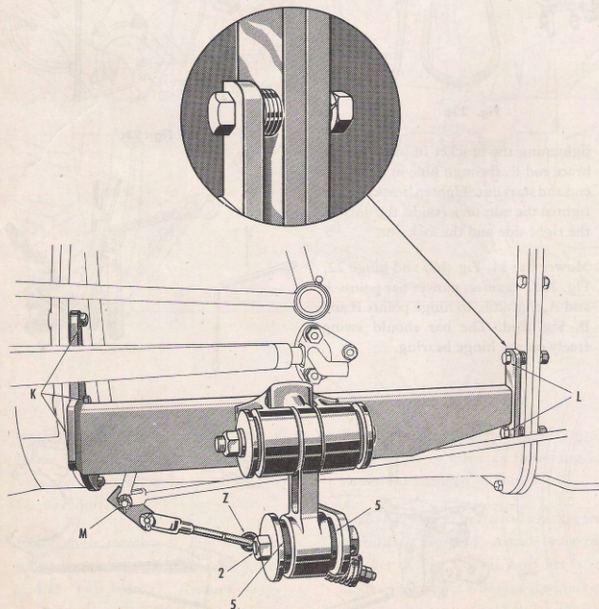

Fig. 24

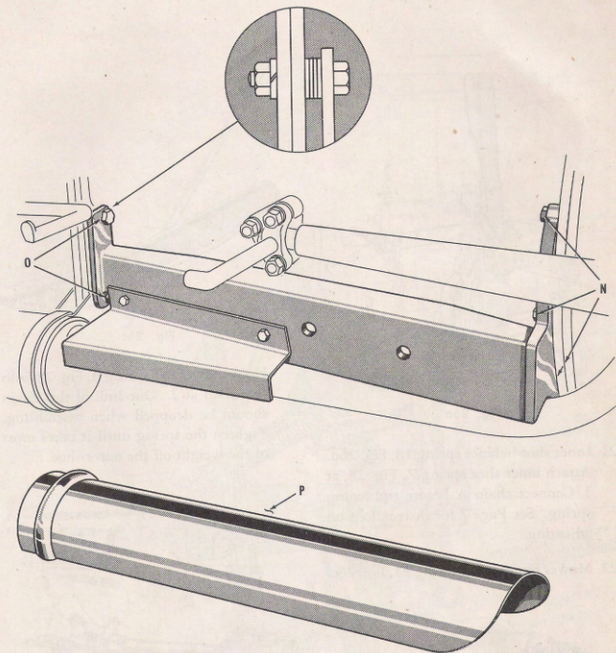

Fig. 25

18. Attach pulley housing to the two lugs on support bracket by means of the long pin T, Fig. 23b.
19. Tilt Lever 17 and ratchet 16, Fig. 26d. Install tilt lever U, Fig. 27, and ratchet V and connect ball socket W.

20. Pull spring 19, Fig. 26d. Hook pull spring bracket X, Fig. 28, cover the right front axle close to the radiator. Hook the rear of the spring into the first link Y. See Page 7 for instructions on adjusting.

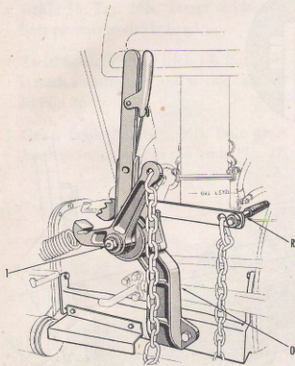

Fig. 26a

21. Inner shoe balance spring 18, Fig. 26d. Attach inner shoe spring Z, Fig. 28, at 1. Connect chain A before tightening spring. See Page 7 for instructions on adjusting.

22. Mower bar balance spring 21, Fig. 26c.

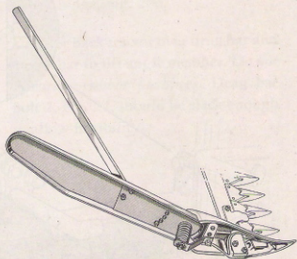

Fig. 26c

Hook mower bar spring B, Fig. 28, into the chain at 2. One link of this chain should be dropped when assembling. Tighten the spring until it takes most of the weight off the outer shoe.

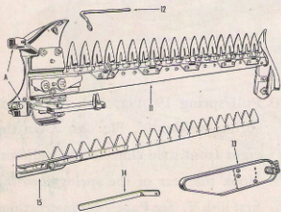

Fig. 26b

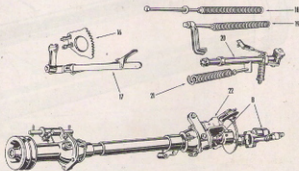

Fig. 26d

23. Connect cable. Clamp as close to the eye C, Fig. 28, as possible and don't let over 1" of cable project beyond clamp. Too short a cable may cause the mower to jam tight against the frame, before the automatic control stops the lift arm. In this case the hydraulic system will

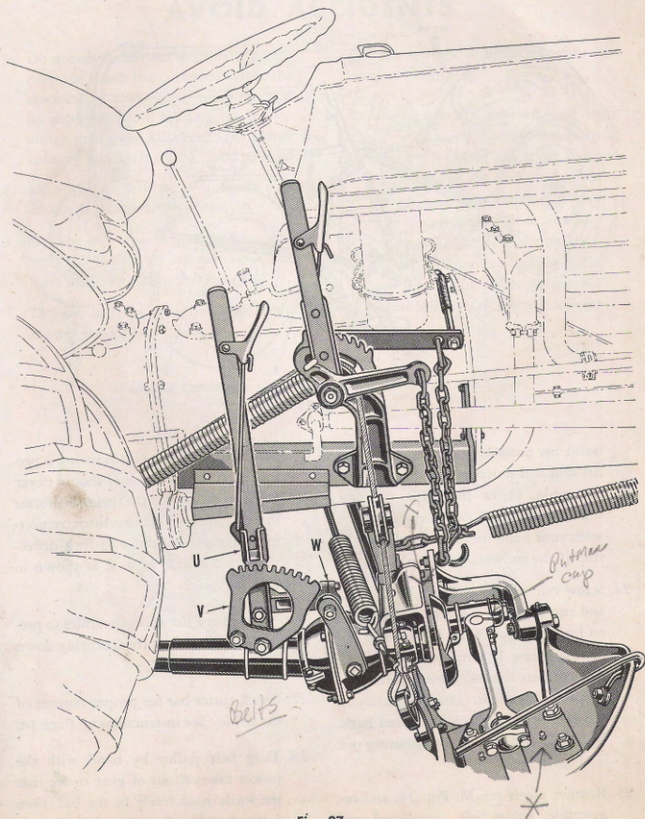

Fig. 27

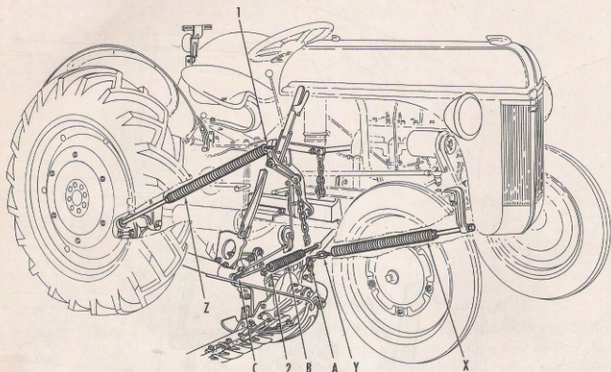

Fig. 28

build up pressure and may bend the lift arm and cause wear or breakage of the cable. Check the cable the first time the mower is raised and be ready with your hand on the control lever to stop if the mower comes up too high.

24. Screw out adjusting screw D, Fig. 29 and run belts on. Tighten hub bolts E on large pulley. Then tighten the adjusting screw D until belts have $\frac{1}{2}$ " deflection as shown. Check belts pulleys for alignment. If small pulley is too far forward it can be spaced back by using washers on pulley housing pin T, Fig. 23b.
25. Remove clevis pin M, Fig. 24, and re-assemble, using bolt, castellated nut

and cotter pin. The clutch spring is pre-loaded at the factory and should never be tightened so that the spring is shorter than $3\frac{1}{2}$ inches. Adjust clutch connecting linkage to allow a $\frac{1}{2}$ -inch deflection from points M to Z as shown in Fig. 24.

26. Adjust draw bar stay assemblies to prevent the lower link from bearing down on the belt guard.
27. Check cutter bar for proper register of the sickle. See instructions on Page 14.
28. Turn belt pulley by hand with the power take-off out of gear to see that the knife runs freely in the bar, then follow breaking in instructions, Page 3.

AVOID ACCIDENTS

1. Do not allow anyone to inspect, check, clear, or touch the cutterbar while the tractor and mower are being stopped by depressing and holding the tractor clutch depressed. *Disengage the power take-off and shift tractor into neutral.*
2. Do not allow children or livestock near or around a mower in operation.
3. Do not start the mower with anyone near the mower or tractor. Look and wait until the mower is clear.
4. Do not attempt to adjust while the mower is running.
5. Do not attempt to lubricate while the mower is running.
6. Disengage power take-off and shift tractor into neutral before touching or allowing anyone to touch the mower.

Regardless of the care used in the design and construction of any type of equipment, there are many conditions that can not be completely safeguarded against without interfering with reasonable accessibility and efficient operation.

A careful operator is the best insurance against an accident.

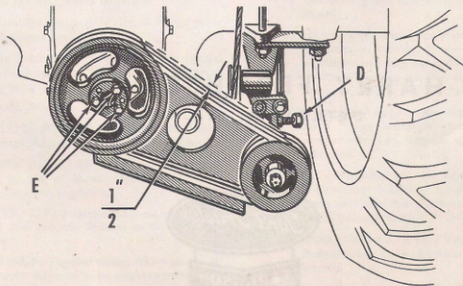

Fig. 29

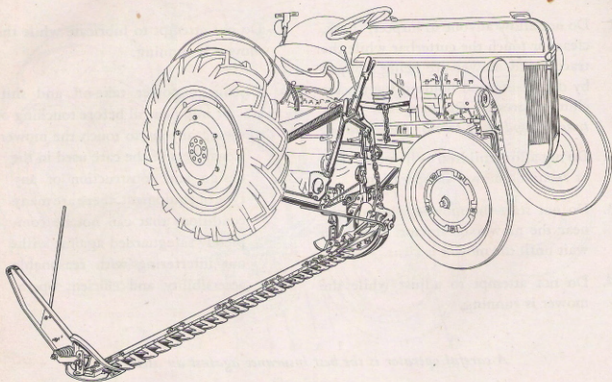

Fig. 30

HARRY FERGUSON, INC.
DETROIT 3, MICHIGAN



SPECIFICATIONS

- CUTTER BAR:** Five or six foot—optional. Cold rolled steel, ribbed at back for stiffness.
- INNER & CUTTER SHOES:** Malleable Iron with hardened steel soles.
- GUARDS:** Malleable Iron with hardened serrated ledger plates. Three-inch spacing provided. Guards—23 per six foot bar, 19 per five foot bar.
- KNIFE CLIPS:** Hardened Steel. Six clips per six foot bar; five clips per five foot bar.
- WEAR PLATES:** Hardened Steel. Six plates per six foot bar; five plates per five foot bar.
- HINGE PINS:** Hardened and ground.
- KNIFE:** Five or six foot—optional. Stroke 9-inches. Reinforcement strip on top of knife.
- KNIFE SECTIONS:** Hardened Tool Steel—3" wide 60° included angle. Plain cutting edge, 24 sections per six foot bar; 20 sections per five foot bar.
- KNIFE HEAD:** One-piece steel forging with large guide surfaces. Knife head guides exceptionally large and rigid.
- INNER SHOE:** Malleable Iron. Has wearing plates for knife head. Large wide spread reamed hinge bearings. Rear hinge bearing split for quick removal. Extra large sole.
- HINGE:** Malleable Iron strongly ribbed. Hinge pivot on hardened steel tube.
- PITMAN:** Malleable Iron, with detachable forged and hardened steel ball caps. Self-aligning. Fork pivots on large bronze bearings.
- LUBRICATION:** Pressure Fittings.
- PITMAN CRANK BEARING:** Large tapered roller bearings. Adjustable. Protected by oil seal.
- PITMAN BALL JOINT:** Hardened. Quickly adjustable by use of shims. Quickly removable caps for replacing knife.
- CRANKSHAFT:** 1.190 diameter. Chrome steel, hardened and ground. Splined to fit Universal Joint.
- MAIN BEARINGS:** Tapered roller, .812 wide x 2.50 diameter. Adjustment by means of shims. Protected by leather oil seals.
- CRANK PIN:** Pressed into flywheel. Removal for replacement.
- FLYWHEEL:** 7¼" dia. Counter balanced. Welded to crankshaft.
- HYDRAULIC LIFT:** High strength stranded plow steel cable connects to right hand lift lever on tractor. Machined guide sheaves.
- PROPELLER SHAFT:** Enclosed in heavy steel cover tube.
- TILT LEVER:** Quick tilt, easily reached from driver's seat. Wide tilt range up and down.
- V-PULLEY DRIVE:** Choice of high or low speed. Mower runs at 1035 R.P.M. with high speed drive at 1600 R.P.M. of engine. Mower runs at 922 R.P.M. with low speed drive at 1600 R.P.M. of engine. Heavy double V-belts 1½" wide x ¾" thick. Instant belt adjustment. Drive Pulley attaches to power take-off shaft by split tapered bushing. Low speed drive pulley PEO-6152 (8½" dia.); high speed drive pulley PEO-6153 (9¾" dia.) Belts for low speed drive PEO-1531 (54" long); belts for high speed drive PEO-1530 (56" long). Driven pulley splined to 1" shaft. Driven pulley the same for high or low speed. Driven pulley mounted on tapered roller bearings .81 wide x 2.50 dia.
- UNIVERSAL JOINTS:** Heavy duty needle bearing. Universal joints and drive shafts fully enclosed.
- FRAME:** Heavy angle iron permanently attached to transmission housing. Frame short and close to tractor and does not interfere with crops or other implements. Wt. of frame 30 lbs. Frame with Drag Bar Bracket weighs 45 lbs.
- MOUNTING:** Drag bar bracket supported in two large rubber bushings which act both in compression and torsion, thus dampening vibration.
- CURB LIFT:** (Provided as extra equipment.) Hand lever adjusts height of inner shoe to maximum of 12 inches. Consists of hand lever PEO-8090 and Ratchet PEO-7998-R.
- HITCH FOR IMPLEMENTS:** Regular Ferguson System lower links and draw bar remain on tractor.
- WEIGHT** (with extra sickle and swathboard, and rockguards): 5 ft. Mower, 453 lbs.; 6 ft. Mower, 463 lbs. Shipping weight—5 ft. Mower, 530 lbs.; 6 ft. Mower, 540 lbs. Weight of Curb lever attachment PEO-51 is 6½ lbs.

I N D E X

	<i>Page</i>
Assembly Instructions.....	20
Bar Alignment.....	15
Belt Tension.....	14
Breaking-in Period.....	3
Checking Register.....	14
Clips.....	13
Clutch Throwout Spring.....	7
Crankshaft Bearings.....	17
Curb Lift.....	5
Excessive Side Draft.....	17
Excessive Vibration.....	18
Guards.....	12
Inner Shoe Spring.....	7
Introduction.....	1
Knife Back.....	11
Knife Breaks.....	18
Lubrication.....	2
Mower Bar Spring.....	6
Mowing Speed.....	9
Pitman.....	11
Pitman Ball.....	15
Pitman Box Bearing.....	17
Pull Spring.....	7
Pull Spring Adjustment.....	7
Pulley Housing Bearings.....	17
Ragged Cutting.....	18
Register Adjustment.....	15
Removal of Sickle Sections.....	11
Removing the Mower.....	19
Replacing Sickle.....	11
Safety Release.....	3
Sharpening Sickle.....	11
Shoe Adjustment.....	5
Sickle Register.....	14
Specifications.....	31
Swathboard and Stick.....	6
Tilt Lever.....	5
Tractor Engine Speed.....	10
Transporting.....	8
Universal Ball Caps.....	17
Wearing Plates.....	14
Winter Care.....	19
Wrist Pin.....	16

See Your Dealer for Information on the
FORD-FERGUSON TRACTOR



THE FERGUSON LINE

Of Implements Includes

Single-Bottom Plows	Row-Crop Cultivators
Double-Bottom Plows	Spring-Tine Cultivators
Disc Plows	Four-Row Weeder.
Disc Terracers	Farm Mowers
Blade Terracers	Heavy Duty Mowers
Middlebusters	Wood Bros. Corn Pickers
Lister Planters	Transport Boxes
Tillers	Sweep Rakes
Single Disc Harrows	Feed Grinders
Tandem Disc Harrows	Two-Way Plows
Spring Tooth Harrows	Cordwood Saws

$\frac{3}{4}$ Ton 2 Wheel Wagon

